

Product overview

ISOMETER[®]

Insulation monitoring devices
for industrial applications

ISOSCAN[®]

EDS insulation fault
location systems



Design the future
of energy

 BENDER

Table of contents

Unearthed power supply systems	4
IT systems – information ahead of time	6
ISOMETER® insulation monitoring devices	
Main circuits	8
Control and auxiliary circuits	10
Main circuits with particular requirements	12
Special applications	14
Accessories	
Coupling devices	22
Measuring instruments	23
Gateways	24
EDS insulation fault location system	
ISOMETER® with locating current injector	26
ISOSCAN®	28
Portable equipment	30
Communication solutions	32
Retrofits	34
Service	35
POWERSCOUT®	36
Bender. Making your world safe.	38

+ - + - + -
- + - + - + - + - +
+ - + - + - + - + -
- + - + - + - + - +
+ - + - + - + - + -



Unearthed power supply systems



Reporting critical operating states to avoid unwanted events, such as interruptions to operation, costly damage to property or even physical injuries.

Safe power supply

To ensure electrical safety for man and machine in an efficient way on a long-term basis, Bender offers insulation monitoring devices for all key industries. In particular, these devices are used anywhere where a safe power supply is an essential requirement to prevent installation failure, eliminate the risk of serious or fatal injuries and avoid damage to property.

Top-level productivity and maximum safety for man and machine

With Bender insulation monitoring devices for unearthed power supplies (IT systems) you are already using state-of-the-art technology in terms of reliability, measurement methods and design. Along with precise measurement equipment, the ISOMETER[®]s provide many functions for early detection and quality assurance with user-friendly and intuitive operation, reliable evaluation and diverse communication possibilities.



Fast localisation of insulation faults

Bender insulation fault location systems enable fast localisation and elimination of insulation faults even during operation. Disconnection of the installation is not required. Portable Bender solutions facilitate the use in large installations with sub-distributions.

For more than 75 years, Bender has been a name for advanced technology using the latest "Made in Germany" measurement equipment and outstanding technical expertise. Trust the technology from the inventor of the ISOMETER®!

Industry-specific solutions for

- Photovoltaic systems
- Installations with a low-resistance insulation level
- Deenergised loads
- Railway – Infrastructure & rolling stock
- Mobile generators



IT systems

Information ahead of time

Modern power supplies require maximum availability, safety and predictive information

Given the wide variety of production processes, continuous competitive pressure, the impact of soaring costs and operational availability around the clock, the maximum possible level of electrical safety for power supplies is required. Even with careful planning, execution and maintenance, electrical installations may nevertheless be impaired by factors such as humidity, ageing, dirt, mechanical damage, to mention but a few. Undetected insulation faults can be disastrous and costly, especially when factors such as production failure, repairs, device replacement or even unplanned service work are counted.

The aim: reduce costs – increase availability

The aim of every plant operator should be to detect malfunctions at an early stage and eliminate the causes economically in order to achieve optimal installation and operational reliability and ultimately reduce costs significantly. To achieve this objective, a possible solution is the use of unearthed power supplies (IT systems) with insulation monitoring.



In IT systems, none of the active conductors is directly connected to earth. Therefore, on the occurrence of an insulation fault, only a small leakage current, essentially caused by system leakage capacitances, can flow.

The upstream fuse does not trip, hence continuous power supply and operation is ensured. Prompt information about possible hazards is given by the ISOMETER®, which continuously monitors the insulation resistance between the system and earth.

Information advantage through the ISOMETER®

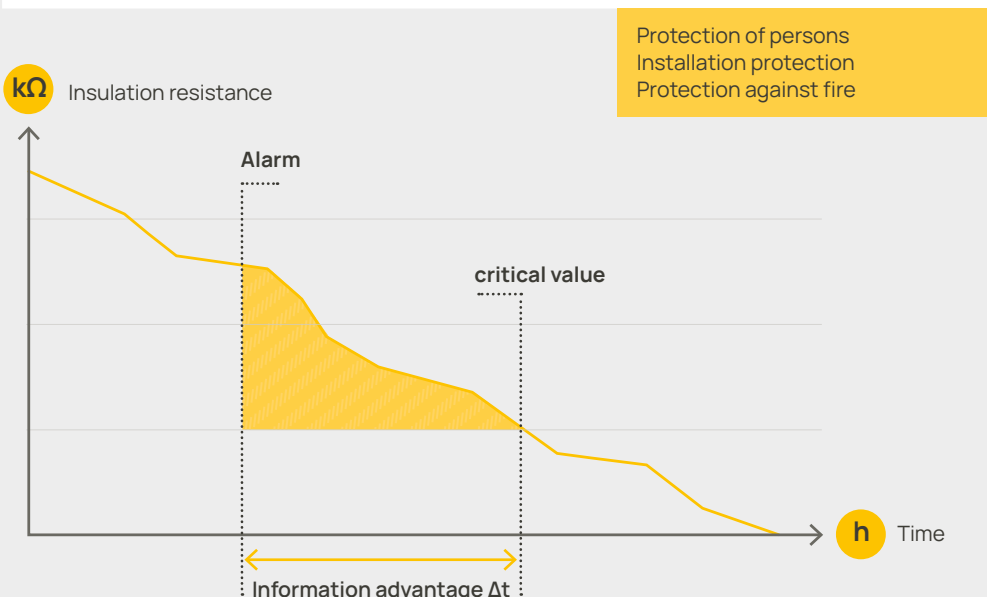

ISOMETER®: a wide variety of solutions for all types of IT systems

For the whole range of electrical power supplies, Bender provides appropriate solutions for most applications. Taking all types of system structures and loads into account, ISOMETER®s using Bender's patented measuring principles guarantee reliable evaluation of the insulation resistance for:

- Nominal system voltages AC, DC or AC/DC up to 15.5 kV
- System types 1ph, 3ph, deenergised loads
- System leakage capacitances up to 4000 μF
- Response values in various device variants from 10 Ω to 3 G Ω

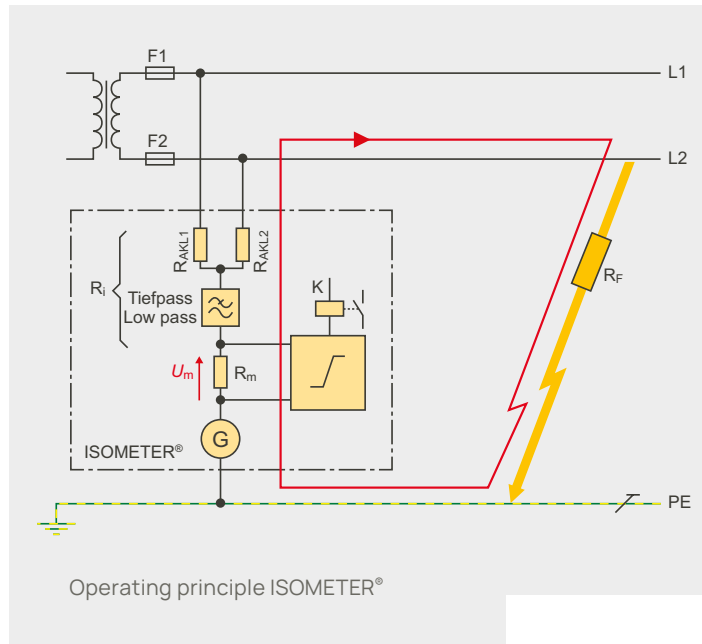

IT systems – information ahead of time

ISOMETER®s in IT systems are an effective means of damage prevention, they enable increased productivity and optimised maintenance, which in turn lead to considerable reduction in costs. Bender's wide range of products allows the implementation of individual safety solutions and safeguards your investment.



Optimised maintenance

- Early detection and reporting of insulation degradation
- Automatic localisation of faulty current paths
- Optimised use of time and personnel resources
- Centralised information about the installation status
- Remote diagnosis via Internet/Ethernet



Increased fire protection

- Early detection of gradually developing insulation faults
- Minimising fault arcs as a common cause of fire
- Separating areas prone to explosions and fire from the rest of the system via isolating transformers and monitoring these areas separately



Improved economic efficiency

- Avoiding expensive and unplanned installation shutdowns
- Reducing time and staff expenses for maintenance
- Detecting weak points in installations
- Support of investment decisions



Increased operational reliability

- No interruption to operation at the first fault
- No control malfunction in the event of insulation faults
- Electrical installations are kept at a high level of availability
- Monitoring electrical installations and loads even when not in operation



Enhanced accident prevention

- Low touch currents in small and medium-sized installations
- No malfunction in control systems of installations and machines due to an earth fault



Higher earthing resistances

- Higher earthing resistances permissible, for example, for mobile power supplies

ISOMETER® insulation monitoring devices

Maximum operational reliability in main circuits

		ISOMETER® iso685-...	ISOMETER® iso685-...-B	ISOMETER® iso685-...-P	ISOMETER® isoNAV685-D	ISOMETER® isoNAV685-D-B	ISOMETER® isoHR685W-...-B
Application					Quick response to combined resistance and offset voltage measurement	Deenergised loads/ frequency converters	High-resistance insulation measurement
Circuits	Control circuits	✓	✓	✓	✓	✓	✓
	Auxiliary circuits	✓	✓	✓	✓	✓	✓
	Main circuits	✓	✓	✓	✓	✓	✓
Voltage system	3(N)AC	✓	✓	✓	✓	✓	✓
	AC	✓	✓	✓	✓	✓	✓
	AC/DC	✓	✓	✓	✓	✓	✓
	DC	✓	✓	✓	—	✓	✓
Nominal system voltage U_n		AC, 3(N)AC 0...690 V DC 0...1000 V	AC, 3(N)AC 0...690 V DC 0...1000 V	AC, 3(N)AC 0...690 V DC 0...1000 V	AC, 3(N)AC 0...690 V (60 Hz)	AC 0...690 V DC 0...1000 V	AC 0...1000 V 3AC 0...690 V DC 0...1300 V
Tolerance of U_n		+15 %	+15 %	+15 %	+15 %	—	+15 %
System leakage capacitance C_e		≤ 1000 µF	≤ 1000 µF	≤ 1000 µF	≤ 1000 µF	≤ 1000 µF	≤ 1000 µF
Response value R_{an}		1 kΩ...10 MΩ	1 kΩ...10 MΩ	1 kΩ...10 MΩ	1 kΩ...10 MΩ	1 kΩ...10 MΩ	1 kΩ...3 GΩ
Coupled systems		—	✓	✓	—	—	✓
Locating current injector for insulation fault location		—	—	✓	—	—	—
Mounting	DIN rail	✓	✓	✓	✓	✓	✓
	Screw mounting	✓	✓	✓	✓	✓	✓
	Panel mounting/ wall fastening	✓	✓	✓	—	—	✓
Interface	Web server	✓	✓	✓	✓	✓	✓
	Modbus	TCP/RTU	TCP/RTU	TCP/RTU	TCP	TCP	TCP
	BCOM	✓	✓	✓	✓	✓	✓
	BS	✓	✓	✓	✓	✓	✓
	isoData	✓	✓	✓	—	—	✓

Ordering information

Type	Supply voltage U_s	Nominal system voltage U_n	Panel mounting	Option "W" ¹⁾	Art. No.
iso685-D	AC 24...240 V; 50...400 Hz/ DC 24...240 V	AC, 3(N)AC 0...690 V; 1...460 Hz/ DC 0...1000 V	—	—	B91067010
iso685W-D ¹⁾			—	-40...+70 °C, 3K23, 3M12	B91067010W
iso685-S + FP200			✓	—	B91067210
iso685W-S + FP200W ¹⁾			—	-40...+70 °C, 3K23, 3M12	B91067210W
iso685-D-B			—	—	B91067020
iso685W-D-B ¹⁾			—	-40...+70 °C, 3K23, 3M12	B91067020W
iso685-S-B + FP200			✓	—	B91067220
iso685W-S-B + FP200W ¹⁾			—	-40...+70 °C, 3K23, 3M12	B91067220W
iso685-D-P			—	—	B91067030
iso685W-D-P ¹⁾			—	-40...+70 °C, 3K23, 3M12	B91067030W
iso685-S-P + FP200			✓	—	B91067230
iso685W-S-P + FP200W ¹⁾			—	-40...+70 °C, 3K23, 3M12	B91067230W
isoNAV685-D			AC, 3(N)AC 0...690 V (60 Hz)	—	B91067014
isoNAV685-D-B			AC 0...690 V DC 0...1000 V	—	B91067024
isoHR685W-D-I-B ¹⁾	AC 0...1000 V 3AC 0...690 V DC 0...1300 V	—	-40...+70 °C, 3K23, 3M12	B91067025W	
isoHR685W-S-I-B + FP200W ¹⁾	—	-40...+70 °C, 3K23, 3M12	B91067225W		

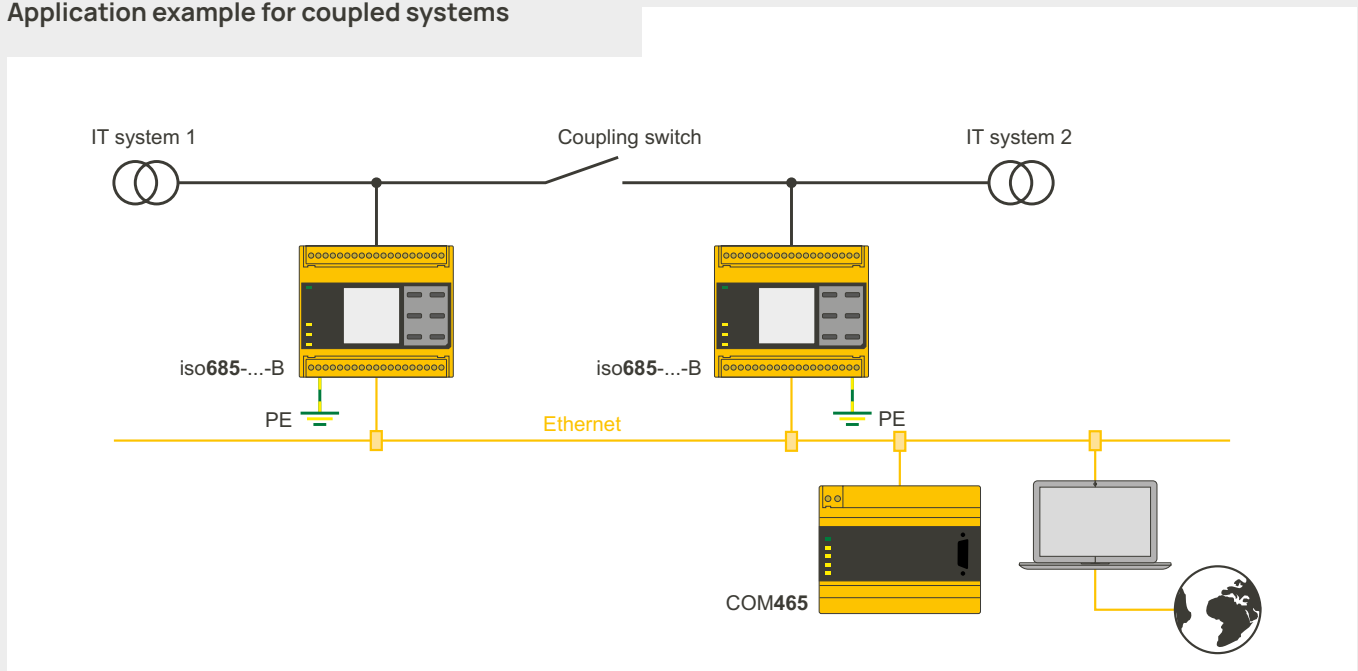

¹⁾ Increased shock and vibration resistance 3K23 and 3M12

Application example for coupled systems



ISOMETER® insulation monitoring devices

Maximum operational reliability in control and auxiliary circuits

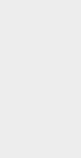
	  ISOMETER® iso415R	 ISOMETER® IR420-D4	 ISOMETER® IR425	
Circuits	Control circuits	✓	✓	✓
	Main circuits	—	—	—
Voltage system	3(N)AC	✓	—	—
	AC	✓	✓	✓
	AC/DC	✓	—	✓
	DC	✓	—	✓
Nominal system voltage U_n		3(N)AC, AC 0...415 V DC 0...400 V	AC 0...300 V	AC / DC 0...300 V
Tolerance of U_n		AC +15% DC +25%	—	—
Frequency range f_n		DC 42...460 Hz	AC 42...460 Hz	DC, AC 15...460 Hz
System leakage capacitance C_e		≤ 25 μF	≤ 20 μF	≤ 20 μF
Response value	Response value R_{an}	5 kΩ...1 MΩ	1...200 kΩ	1...200 kΩ
	Alarm contacts	1 changeover contact	2 changeover contacts	2 changeover contacts
	Operating principle	N/O or N/C operation	N/O or N/C operation	N/O or N/C operation
	Response time $t_{an}^{1)}$	≤ 6 s	≤ 1 s	≤ 2 s
	Start-up delay t	0...1800 s	0...10 s	0...10 s
	Response delay t_{on}	0...1800 s	0...99 s	0...99 s
Display	LC display	—	✓	✓
	Power On LED	✓	✓	✓
	Alarm LEDs	✓	✓	✓
Mounting	DIN rail	✓	✓	✓
	Screw mounting	✓	✓	✓

¹⁾ at $R_f = 0.5 \times R_{an}$ and $C_e = 1 \mu F$

Ordering information

Type	Nominal voltage U_n	Supply voltage $U_s^{2)}$	Art. No.	
			Screw-type terminal	Push-wire terminal
iso415R-24	3(N)AC, AC 0...415 V / DC 0...400 V /	DC 24 V (unearthed)	—	B71602000
iso415R-2	(3)AC 100...240 V, 3(N)AC 100...415 V DC 100...240 V	AC/DC 100 ... 240 V	—	B71603000
IR420-D4-1	AC 0...300 V, 42...460 Hz	AC 16...72 V, 42...460 Hz/DC 9.6...94 V	B91016409	B71016409
IR420-D4-2		AC/DC 70...300 V/DC 42...460 Hz	B91016405	B71016405
IR425-D4-1	AC/DC 0...300 V, 15...460 Hz	AC 16...72 V, 15...460 Hz/DC 9.6...94 V	B91036403	B71036403
IR425-D4-2		AC/DC 70...300 V/DC 15...460 Hz	B91036402	B71036402

²⁾ Absolute values



In localised areas, such as machine control systems or safety lighting, where space is limited, control and auxiliary circuits provide additional functions, e.g. command output, interlocking, signalling and measuring. Operational reliability is the main focus of these circuits. Control circuits are restricted in terms of space, e.g. machine controls or safety lighting.

Bender Connect App

The Bender Connect App is a straightforward solution that allows you to conveniently parameterise our latest devices.

- Reading in energised state
- Parameter setting in deenergised state
- Device documentation (PDF documentation of the set parameters)
- Backup of the devices



Application examples

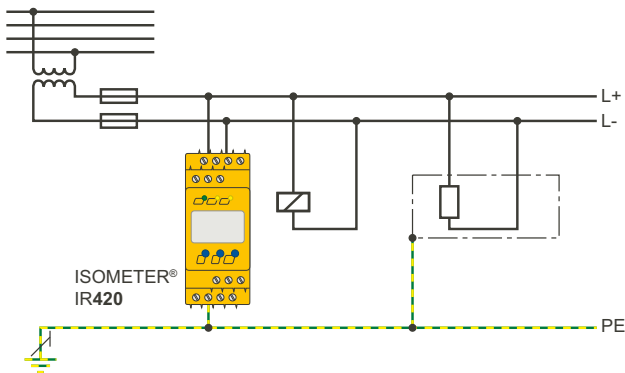

AC control circuit with IR420

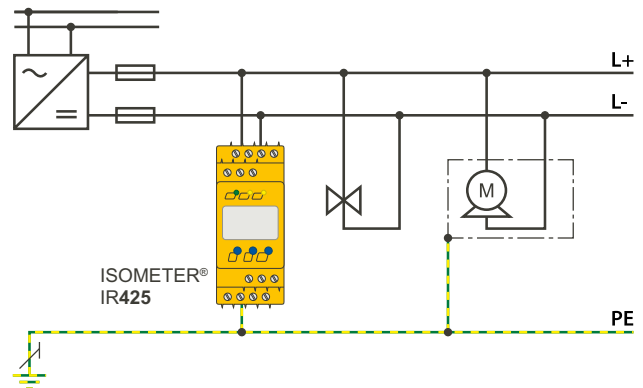

DC control circuit with IR425

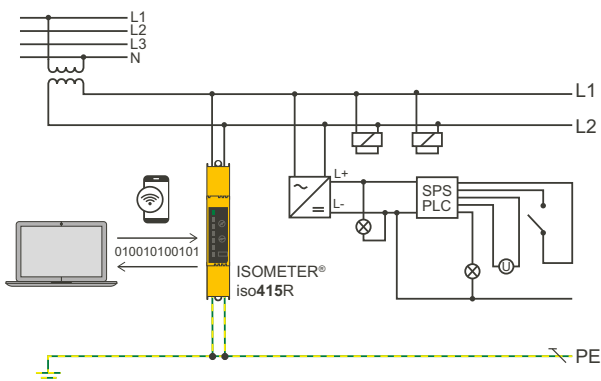

AC/DC control circuit with iso415R-2

ISOMETER® insulation monitoring devices

For main circuits with particular requirements

		ISOMETER® iso1685DP	ISOMETER® isoHV1685D	ISOMETER® isoLR1685DP
Circuits	Control circuits	—	—	—
	Main circuits	✓	✓	✓
Voltage system	3(N)AC	—	—	—
	AC	✓	✓	✓
	AC/DC	✓	✓	✓
	DC	✓	✓	✓
Nominal system voltage U_n		AC 0...1000 V DC 0...1500 V	AC 0...2000 V DC 0...3000 V	AC 0...690 V DC 0...690 V
Tolerance of U_n		AC +10 % DC +5%	AC +10 % DC +5%	AC +10 % DC +5%
System leakage capacitance C_e		≤ 2000 μF	≤ 2000 μF	≤ 2000 μF
Response value R_{an}		200 Ω ...1 MΩ	200 Ω...1 MΩ	20 Ω...100 kΩ
Coupled systems		✓	✓	✓
Mounting	DIN rail	—	—	—
	Screw mounting	✓	✓	✓
Interface	Modbus	RTU	RTU	RTU
	BMS	✓	✓	✓
	isoData	—	—	—

Ordering information

Type	Supply voltage U_s ¹⁾	Response value range	Nominal voltage U_n	Art. No.
iso1685DP-425	DC 18...30 V	200 Ω...1 MΩ	AC 0...1000 V DC 0...1500 V	B91065802
isoHV1685D-425			AC 0...2000 V DC 0...3000 V	B91065805
isoLR1685DP-325		20 Ω...100 kΩ	AC 0...690 V DC 0...690 V	B91065803

¹⁾ Absolute values

Main circuits provide the power supply for electrical installations, machines or buildings. These circuits include equipment for generating, converting, distributing, switching and consuming electrical energy. A distinction should be made between the following loads: pure AC loads (e.g. motors), AC/DC loads containing electronic components (e.g. converters) and pure DC loads (e.g. battery systems).



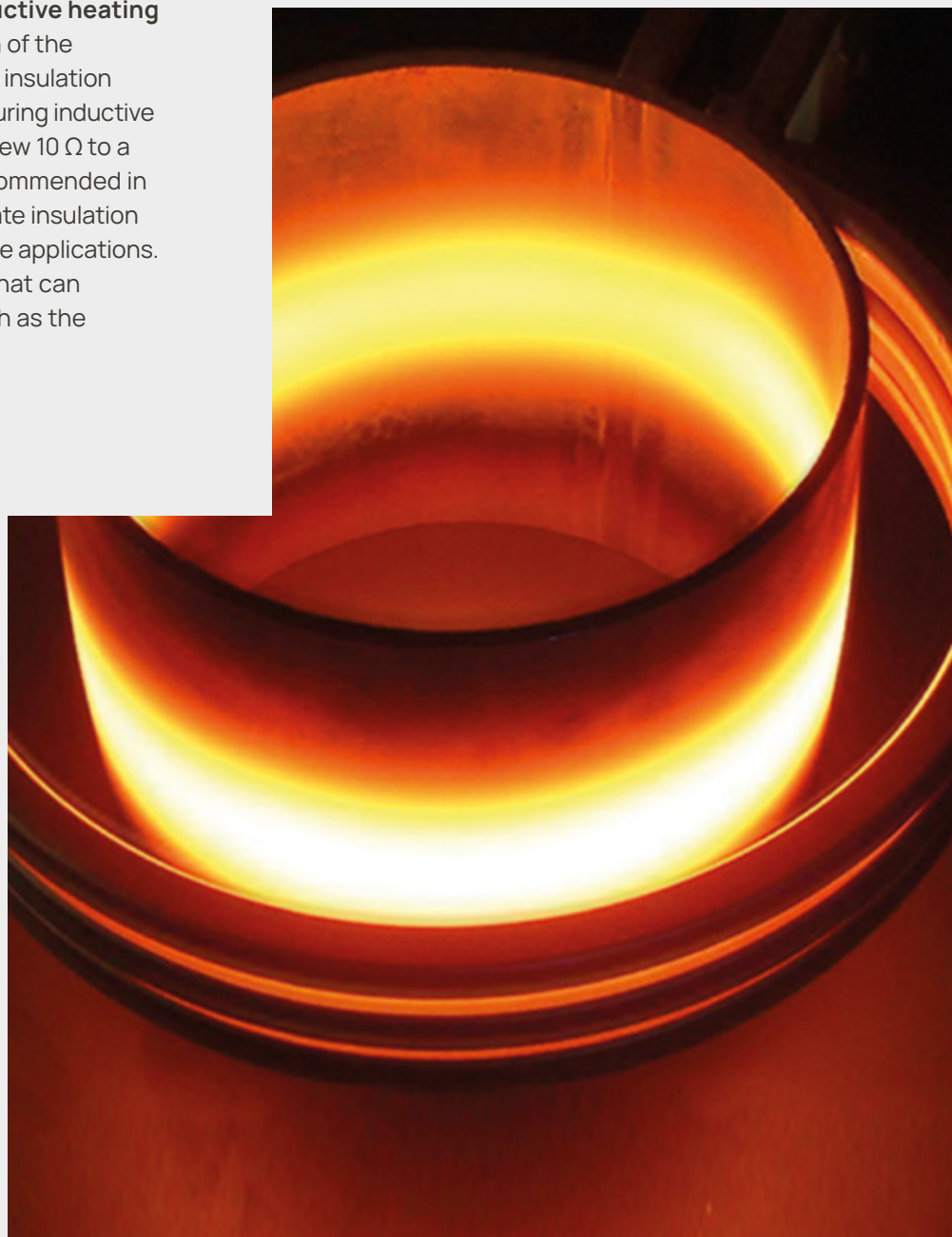

Insulation monitoring devices for inductive heating

Due to the water cooling and the design of the inductor, experience has shown that the insulation resistance of the systems is rather low during inductive heating and often lies in the range of a few $10\ \Omega$ to a few $k\Omega$. To monitor the insulation as recommended in VDE0100-410 or IEC 60364-4-41, appropriate insulation monitoring devices are required for these applications. We offer insulation monitoring devices that can measure very low resistance levels, such as the isoLR1685DP.

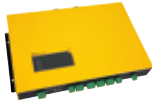

Spezielle Anwendungen

Störungen rechtzeitig erkennen bei Photovoltaik-Großanlagen

Area of use		Photovoltaics			
					
		ISOMETER® isoPV	ISOMETER® isoPV425	ISOMETER® isoPV1685RTU	ISOMETER® isoPV1685DP
Circuits	Control circuits	—	—	—	—
	Main circuits	✓	✓	✓	✓
Voltage system	3(N)AC	✓	—	—	✓
	AC	✓	✓	—	✓
	AC/DC	✓	✓	—	✓
	DC	✓	✓	✓	✓
Nominal system voltage U_n		via AGH-PV 3(N)AC 0...690 V DC 0...1000 V	AC 0...690 V DC 0...1000 V	AC 0...1000 V DC 0...1500 V	AC 0...1000 V DC 0...1500 V
Tolerance of U_n		AC +15% DC +10%	AC +15% DC +10%	AC +10% DC +6%	AC +10% DC +5%
System leakage capacitance C_e		≤ 2000 μF	≤ 500 μF	≤ 2000 μF	≤ 4000 μF
Response value R_{an}		200 Ω...100 kΩ	1 kΩ...990 kΩ	200 Ω...990 kΩ	200 Ω...200 kΩ
Mounting	DIN rail	✓	✓	—	—
	Screw mounting	✓	✓	✓	✓
Interface	Modbus	—	RTU	RTU	RTU
	BMS	✓	✓	✓	✓
	isoData	—	✓	—	—

Ordering information

Type	Nominal system voltage U_n	Supply voltage U_s ¹⁾	Art. No.
isoPV-327 + AGH-PV consisting of: isoPV-327 (B9106 5130W), AGH-PV (B98039020W)	AC 0...690 V/DC 0...1000 V	DC 19.2...72 V	B91065132W
isoPV-335 + AGH-PV consisting of: isoPV-335 (B91065131W), AGH-PV (B98039020W)	AC 0...690 V/DC 0...1000 V	AC 88...264 V/DC 77...286 V	B91065133W
isoPV425-D4-2 with AGH420	AC 0...690 V/DC 0...1000 V	AC 100...240 V, 47...63 Hz/ DC 24...240 V	B71036303 ²⁾
isoPV1685RTU-425	AC 0...1000 V DC 0...1500 V	DC 18...30 V	B91065603
isoPV1685DP			B91065808

¹⁾ Absolute values

²⁾ Device version with screw-type terminals on request

The modern insulation monitoring devices of the ISOMETER® series from Bender can be used to measure and visualise insulation resistance over time. This metrological monitoring gives operators of large-scale photovoltaic systems a head start in terms of information before a critical state occurs. ISOMETER®s as adaptive measuring systems for insulation monitoring thus offer a safe, standard-compliant and simple solution for monitoring insulation deterioration throughout the entire service life of PV systems.

Standard-compliant solutions for renewables, such as

- Photovoltaic systems
- Wind power stations
- Hydroelectric power plants
- Pumped-storage power plants
- Hydrogen electrolysis
- Battery storage systems
- and many more

Application examples

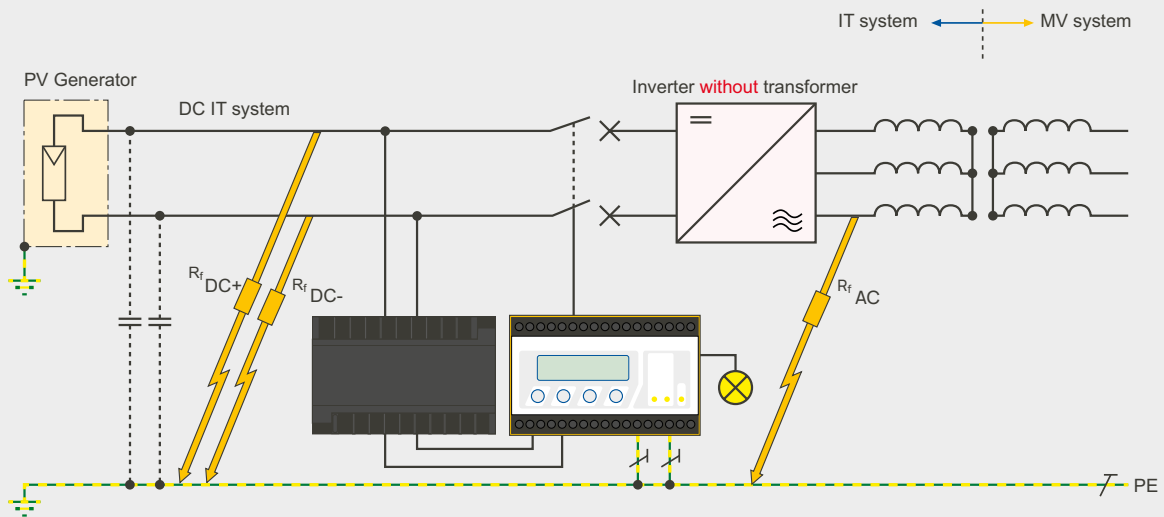

Unearthed PV generator (IT system) with ISOMETER® isoPV and coupling device AGH-PV

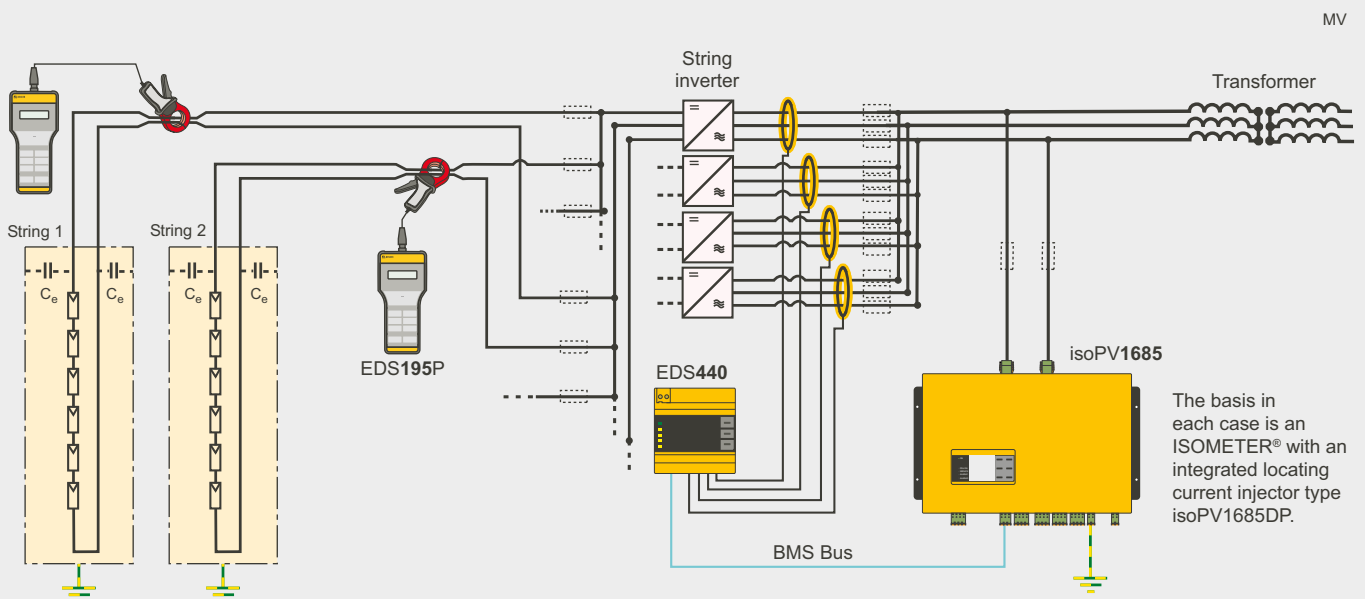

Principle of a photovoltaic system with insulation monitoring and manual/automatic insulation fault location

Special applications



Area of use	Insulated elevating work platforms	AC, DC or AC/DC medium voltage systems	Installations with a low-resistance insulation level	Deenergised loads
				
	ISOMETER® isoHR1685DW	ISOMETER® IRDH275BM-7	ISOMETER® isoLR275	ISOMETER® IR420-D6
Main circuits	✓	✓	✓	✓
Voltage system	3(N)AC	—	✓	✓
	AC	✓	—	✓
	AC/DC	✓	✓	—
	DC	✓	✓	—
Nominal system voltage U_n	AC 0...1000 V DC 0...1500 V	AC, 3(N)AC, DC 0...15.5 kV (absolute)	via AGH-LR 3(N)AC 0...690 V DC 0...1000 V	AC 0...400 V
Tolerance of U_n	AC +10 % DC +5 %	—	AC +15 % DC +10 %	—
System leakage capacitance C_e	≤ 1 µF	≤ 5 µF	≤ 500 µF	≤ 10 µF
Response value R_{an}	100 kΩ...100 MΩ	100 kΩ...10 MΩ	200 Ω...100 kΩ	100 kΩ...10 MΩ
Coupled systems	✓	—	—	—
Mounting	DIN rail	—	✓	✓
	Screw mounting	✓	✓	✓
Interface	Modbus	RTU	—	—
	BMS	✓	✓	—
	isoData	—	✓	—

Ordering information

Type	Nominal system voltage U _n	Supply voltage U _s ¹⁾	Art. No.
isoHR1685DW-925	AC 0...1000 V/DC 0...1500 V	DC 18...30 V	B91065806W
IRDH275BM-7	—	AC 19.2...72 V	B91065120
isoLR275-327 + AGH-LR-3 consisting of: isoLR275-327 (B91065700W), AGH-LR-3 (B98039022W)	AC 0...793 V/DC 0...1100 V	DC 19.2...72 V	B91065702W
isoLR275-335 + AGH-LR-3 consisting of: isoLR275-335 (B91065701W), AGH-LR-3 (B98039022W)		AC 88...264 V/DC 77...286 V	B91065703W
IR420-D6-1	—	AC 16...72 V, 42...460 Hz/DC 9.6...94 V	B71016415 ²⁾
IR420-D6-2		AC 70...300 V, 42...460 Hz/DC 70...300 V	B71016407 ²⁾
IR420-D64-2			B71016408 ²⁾
isoUG425-D4-4	AC 24...240 V, 47...63 Hz/ DC 24...240 V	AC 12...120 V	B71036320
isoES425-D4-4		AC/DC 0...400 V, 15...460 Hz	B71037020

¹⁾ Absolute values

²⁾ Device version with screw-type terminals on request

Unearthed DC systems	Energy storage VDE-AR-E 2510-2
	
ISOMETER® isoUG425	ISOMETER® isoES425
✓	✓
—	✓
—	✓
—	✓
✓	✓
DC 12...120 V	3 (N)AC, AC 0...400 V DC 0...400 V
+20 %	+25 %
≤ 50 μF	≤ 100 μF
2 kΩ...100 kΩ	2 kΩ...990 kΩ
—	—
✓	✓
✓	✓
RTU	—
✓	✓
✓	✓

Application example

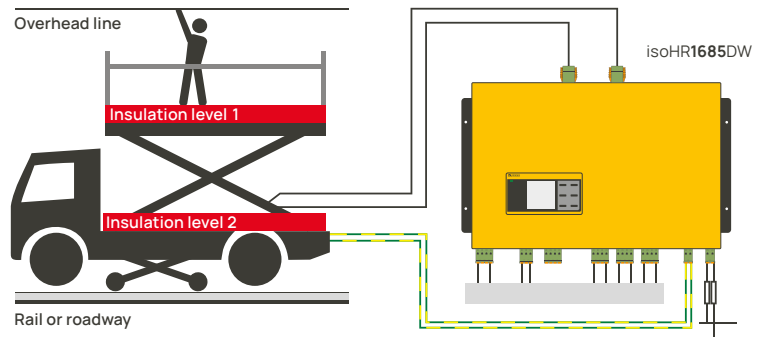

Continuous monitoring of the insulation levels of overhead catenary maintenance vehicles with isoHR1685DW

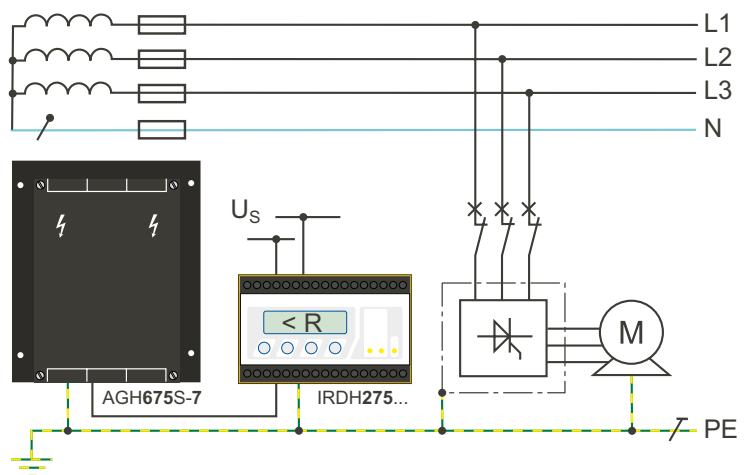

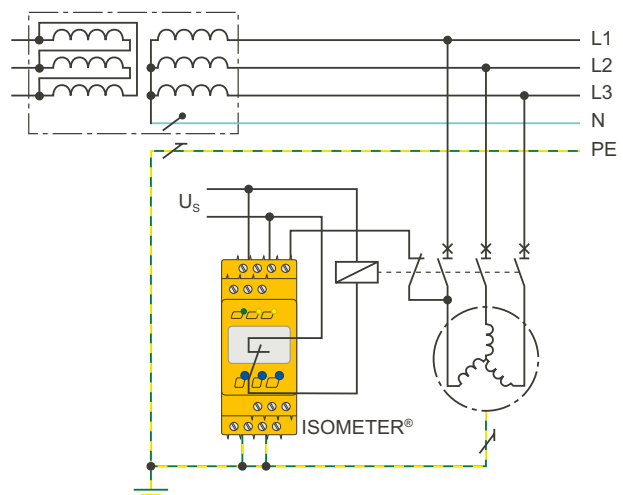

Monitoring of medium-voltage drives with IRDH275... and coupling device AGH675S-7

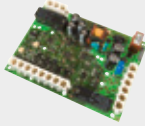

Monitoring of deenergised loads with IR420-D6 (offline)

Special applications

Area of use	Mobile generators	Mobile generators	Generators acc. to standard DIN VDE 0100-551
			
	ISOMETER® IR423	ISOMETER® IR123P	ISOMETER® isoGEN423
Main circuits	✓	✓	✓
Voltage system	3(N)AC	—	✓
	AC	✓	✓
	AC/DC	—	✓
	DC	—	✓
Nominal system voltage U_n	AC 0...300 V	AC 100...250 V	3(N)AC, AC 0...400 V DC 0...400 V
Tolerance of U_n	+ 20 %	+ 20 %	+25 %
System leakage capacitance C_e	$\leq 5 \mu\text{F}$	$\leq 1 \mu\text{F}$	$\leq 5 \mu\text{F}$
Response value R_{an}	1 k Ω ...200 k Ω	46 k Ω /23 k Ω	5 k Ω ...200 k Ω
System isolation function	—	—	✓
Mounting	DIN rail	—	✓
	Screw mounting	✓	✓
Interface	Modbus	—	RTU
	BMS	—	✓
	isoData	—	✓

Ordering information

Type	Nominal system voltage U_n	Supply voltage U_s ¹⁾	Art. No.
IR423-D4-1	AC 0...300 V	AC 16...72 V, 30...460 Hz/ DC 9.6...94 V	B71016304 ²⁾
IR423-D4-2		AC/DC 70...300 V, 30...460 Hz	B71016305 ²⁾
IR423-D4W-1		AC 16...72 V, 30...460 Hz/ DC 9.6...94 V	B71016304W ²⁾
IR423-D4W-2		AC/DC 70...300 V, 30...460 Hz	B71016305W ²⁾
IR123P-4-2	AC 100...300 V, 22...460 Hz	$U_s = U_n$	B91016308
isoGEN423-D4-4	AC 100...240 V/ DC 24...240 V	3(N)AC, AC 0...400 V/DC 0...400 V	B71036325

¹⁾ Absolute values

²⁾ Device version with screw-type terminals on request

Application example

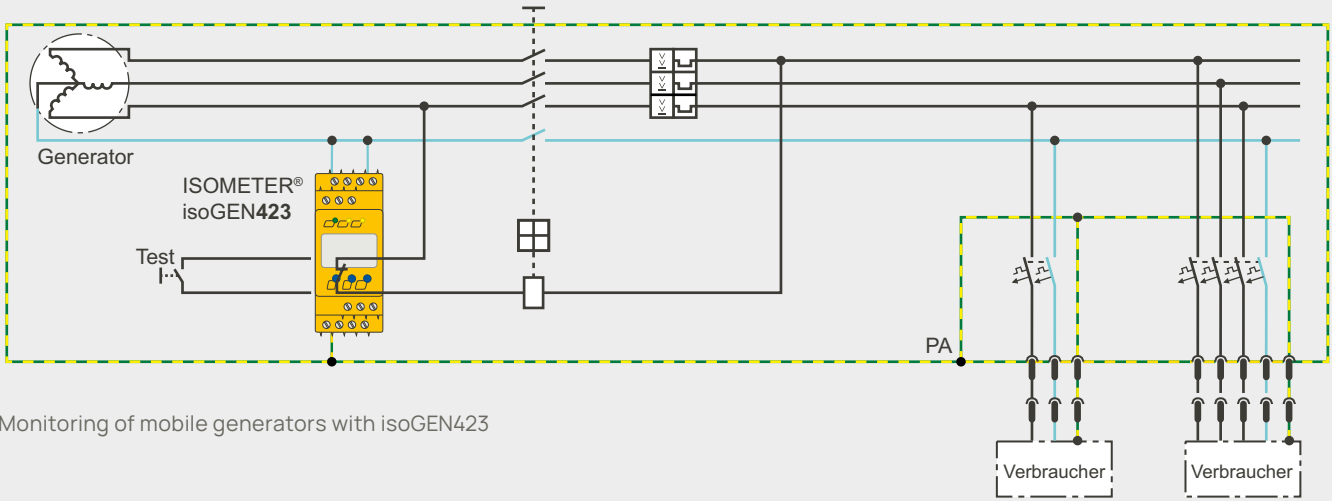



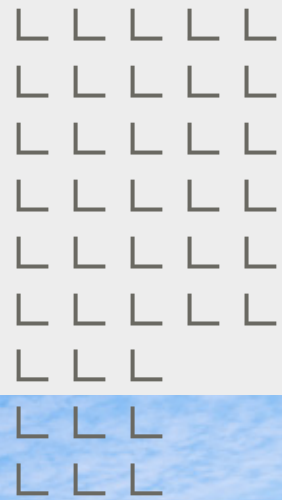

Monitoring of mobile generators with isoGEN423



Special applications

Electrical safety in railway technology

Area of use		Railway, rolling stock			
					
		ISOMETER® isoRW425	ISOMETER® isoRW685W-D	ISOMETER® isoRW685W-D-B	ISOMETER® isoHV425
Circuits	Control circuits	—	✓	✓	—
	Auxiliary circuits	—	✓	✓	—
	Main circuits	✓	✓	✓	✓
Voltage system	3(N)AC	✓	✓	✓	✓
	AC	✓	✓	✓	✓
	AC/DC	✓	✓	✓	✓
	DC	✓	✓	✓	✓
Nominal system voltage U_n		3(N)AC, AC/DC 0...440 V	3(N)AC, AC 0...690 V DC 0...1000 V	3(N)AC, AC 0...690 V DC 0...1000 V	with AGH422 AC 0...1000 V DC 0...1000 V
Tolerance of U_n		+ 15 %	+15 %	+15 %	+10 %
System leakage capacitance C_e		≤ 300 μF	≤ 1000 μF	≤ 1000 μF	≤ 150 μF
Response value R_{an}		1 kΩ...990 kΩ	1 kΩ...10 MΩ	1 kΩ...10 MΩ	10 kΩ...500 kΩ
System isolation function		—	—	✓	✓
Mounting	DIN rail	✓	✓	✓	✓
	Screw mounting	✓	✓	✓	✓
Interface	Web server	—	✓	✓	—
	Modbus	RTU	TCP/RTU	TCP/RTU	RTU
	BCOM	—	✓	✓	—
	BS	—	✓	✓	—
	BMS	✓	—	—	✓
	isoData	✓	✓	✓	✓

Ordering information

Type	Supply voltage U_s ¹⁾	Nominal system voltage U_n	System leakage capacitance C_e	Art. No.
isoRW425-D4W-4	AC 100...240 V / DC 24...240 V	3(N)AC, AC/DC 0...440 V	≤ 300 μF	B71037000W ²⁾
isoRW685W-D	AC 24...240 V, 50...400 Hz / DC 24...240 V	AC 0...690 V, 1...460 Hz / DC 0...1000 V	≤ 1000 μF	B91067012W
isoRW685W-D-B	AC 24...240 V, 50...400 Hz / DC 24...240 V	AC 0...690 V, 0.1...460 Hz / DC 0...1000 V	≤ 1000 μF	B91067022W
isoHV425W-D4-4 with AGH422W	AC 100...240 V, 47...63 Hz / DC 24...240 V	3(N)AC, AC 0...1000 V	≤ 150 μF	B71036501W

¹⁾ Absolute values

²⁾ Device version with screw-type terminals on request

Application examples

Monitoring of the complete IT system
 ≤ 400 V with isoRW425

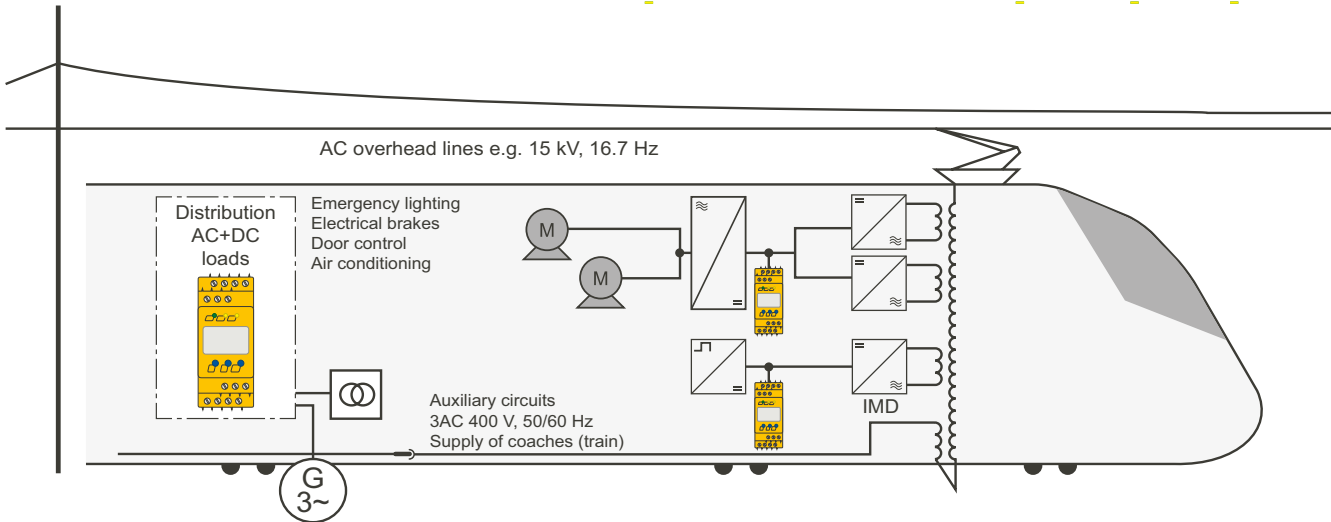
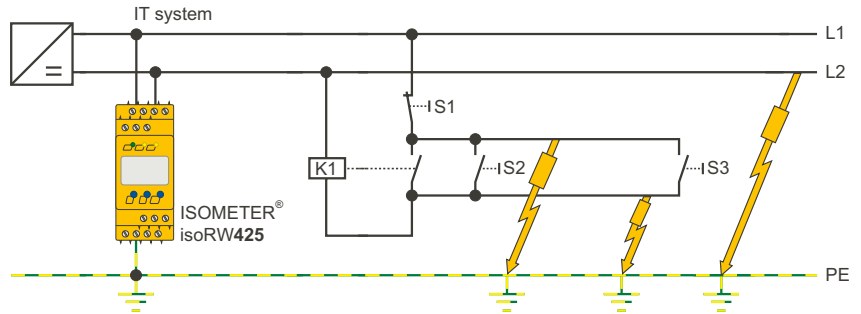

Universal use of the isoRW425 for IT systems ≤ 400 V

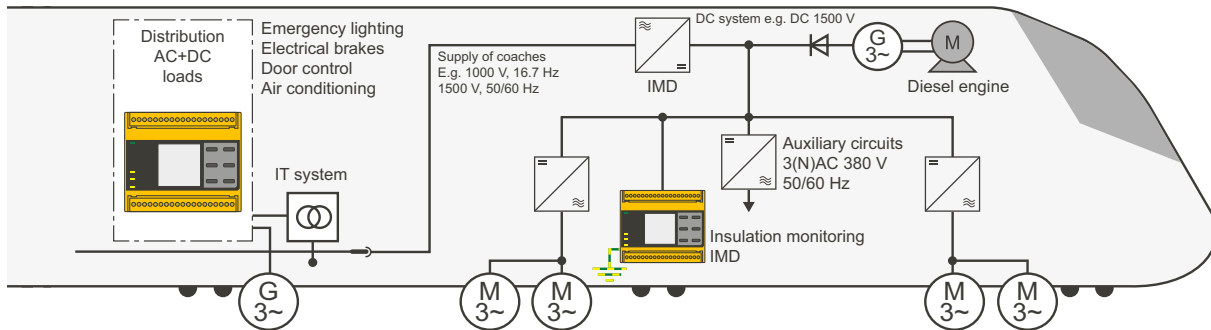



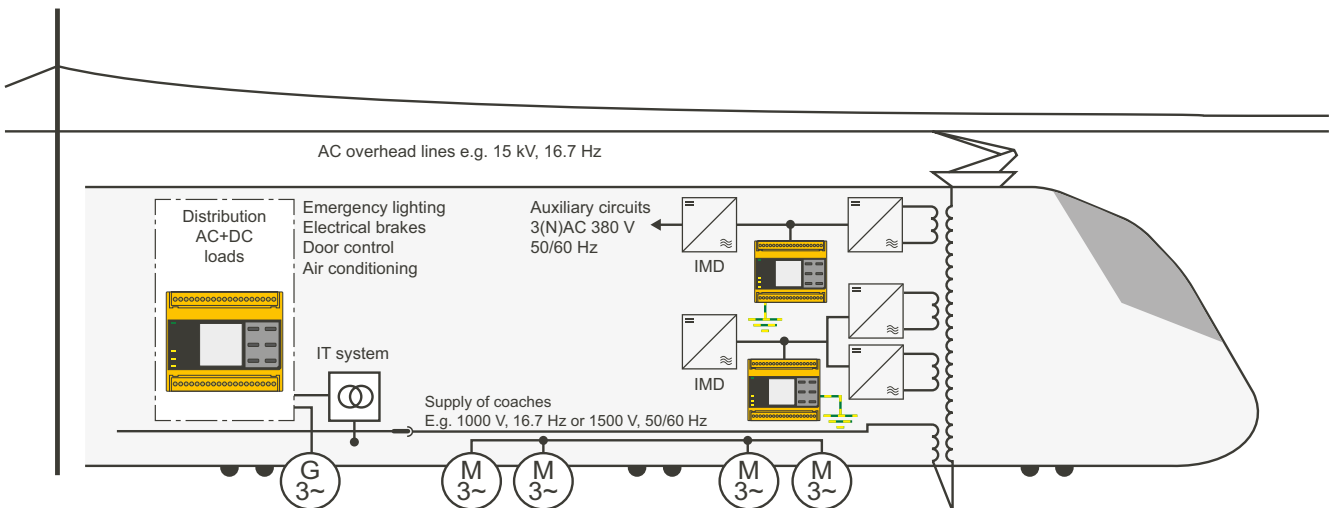



Universal use of the isoRW685 for IT systems > 400 V



Universal use of the isoRW685 for IT systems > 400 V

Accessories

Coupling devices

						
	AGH150W-4	AGH204S-4	AGH520S	AGH676S-4	AGH675S-7	AGH675S-7MV
Application	Nominal voltage extension for ISOMETER®s					
Nominal system voltage U_n	AC 0...1150 V DC 0...1760 V	AC 0...1300 V/ AC 0...1650 V	AC/3(N)AC 0...7200 V	AC/3(N)AC 0...12000 V	AC, 3(N)AC DC 0...7200 V	AC, 3(N)AC DC 0...15500 V
For device family	IRDH275BM-7	—	—	—	✓	✓
	IR420-D64	—	—	—	✓	—
	iso685-D	✓	✓	✓	✓	—
	iso685-S	✓	✓	✓	✓	—

Ordering information

Type	Nominal system voltage U_s	Art. No.
AGH150W-4	AC 0...1150 V/DC 0...1760 V	B98018006
AGH204S-4	AC 0...1650 V/0...1300 V	B914013
AGH520S	3(N)AC 0...7200 V	B913033
AGH675S-7-500	AC, 3(N)AC, DC 0...7200 V, 0...460 Hz	B913060
AGH675S-7-2000		B913061
AGH675S-7MV15-500	AC, 3(N)AC, DC 0...15500 V, 0...460 Hz	B913058
AGH676S-4	AC/ 3(N)AC 0...12000 V, 50...460 Hz	B913055



Accessories

Measuring instruments





	7204	7220	9604	9620
Input current	0...400 μ A	0...20 mA	0...400 μ A	0...20 mA
Dimensions (mm)	72 x 72	72 x 72	96 x 96	96 x 96
For device family iso685...	✓	✓	✓	✓

Ordering information

Type	Input current	Dimensions	Midscale	Art. No.
7204-1421	0...400 μ A	72 x 72 mm	120 k Ω	B986763
7204S-1421				B986804
9604-1421		96 x 96 mm	120 k Ω	B986764
9604S-1421				B986784
9620-1421	0...20 mA	96 x 96 mm	120 k Ω	B986841
9620S-1421				B986842
9604-1621	0...400 μ A	96 x 96 mm	1.2 M Ω	B986782
7220-1421	0...20 mA	72 x 72 mm	120 k Ω	B986844
7220S-1421				B986848

Accessories

Gateway

					
	COMTRAXX® COM465IP	COMTRAXX® COM465DP	COMTRAXX® COM465ID	COMTRAXX® CP9...-I	
Application	Condition monitor, gateway	Condition Monitor, PROFIBUS gateway	Condition Monitor, gateway	Condition Monitor, gateway	
Functions	Protocol input	BMS, BCOM, Modbus RTU/TCP	BMS, BCOM, Modbus RTU/TCP	isoData, Modbus TCP	BMS (internal), BCOM, Modbus RTU/TCP
	Protocol output	Ethernet, Modbus RTU/TCP, SNMP, PROFINET	Ethernet, Modbus RTU/TCP, SNMP, PROFINET, PROFIBUS DP	Ethernet, Modbus TCP, OPC-UA	Ethernet, Modbus RTU/TCP, SNMP, PROFINET
	Display	LED	LED	LED	7" or 15.6" display
	Alarm messages	✓ ^{1,2)}	✓ ^{1,2)}	✓ ^{1,2)}	✓ ^{1,2,3)}
	Measured values	✓ ^{1,2)}	✓ ^{1,2)}	✓ ^{1,2)}	✓ ^{1,2,3)}
	Device parameter setting	✓ ¹⁾	✓ ¹⁾	✓ ¹⁾	✓ ^{1,3)}
	Alarm list	✓ ¹⁾	✓ ¹⁾	✓ ¹⁾	✓ ^{1,3)}
	History memory	✓ ¹⁾	✓ ¹⁾	✓ ¹⁾	✓ ^{1,3)}
	Diagrams	✓ ¹⁾	✓ ¹⁾	✓ ¹⁾	✓ ^{1,3)}
	Visualisation	✓ ¹⁾	✓ ¹⁾	✓ ¹⁾	✓ ^{1,3)}
	E-mail notification	✓ ^{1,4)}	✓ ^{1,4)}	✓ ^{1,4)}	✓ ^{1,4)}
	Device tests	✓ ^{1,2)}	✓ ^{1,2)}	✓ ^{1,2)}	✓ ^{1,2,3)}
	PEM... and energy meter support	✓ ¹⁾	✓ ¹⁾	✓ ¹⁾	✓ ¹⁾
	SNMP	✓ ¹⁾	✓ ¹⁾	✓ ¹⁾	✓ ¹⁾
Data logger	✓ ¹⁾	✓ ¹⁾	✓ ¹⁾	✓ ¹⁾	
Connection	BMS	Screw-type terminal	Screw-type terminal	—	Screw-type terminal
	Modbus RTU	Screw-type terminal	Screw-type terminal	—	Screw-type terminal
	isoData	—	—	Screw-type terminal	—
	Output	RJ45	RJ45, Sub-D 9-pole	RJ45	RJ45
System requirements	Supply voltage U _s	AC/DC 24...240 V	AC/DC 24...240 V	AC/DC 24...240 V	DC 24 V
	Browser	Edge, Chrome, Firefox etc.	Edge, Chrome, Firefox etc.	Edge, Chrome, Firefox etc.	Edge, Chrome, Firefox etc.

1) Available functions on the web server – accessible via a PC with a browser

2) Available via the protocol

3) On the device-internal LC display

4) TLS/SSL support

Ordering information

Type	Supply voltage/frequency range U_s	Power consumption	Art. No.
COM465IP-230V	AC/DC 24...240 V, 50...60 Hz	$\leq 6.5 \text{ VA}, \leq 4 \text{ W}$	B95061065
COM465DP-230V	AC/DC 24...240 V, 50...60 Hz	$\leq 6.5 \text{ VA}, \leq 4 \text{ W}$	B95061060
COM465ID-230 V	AC/DC 24...240 V, 50...60 Hz	$\leq 6.5 \text{ VA} / \leq 4 \text{ W}$	B95061070
CP907-I	DC 24	$\leq 15 \text{ W}$	B95061031
CP915-I (white)	AC 100...240 V	$\leq 30 \text{ W}$	B95061033
CP915-I (grey)			B95061034

Function modules for COM465IP and COM465DP

Function module (software licence)	Application	Art. No.
Function module A	Individual text messages for all devices/channels, device failure monitoring, e-mail in case of an alarm, device documentation	B75061011
Function module B	Data is provided via Modbus TCP and Modbus RTU, SNMP server with trap function	B75061012
Function module C	Parameter setting of all integrated devices, device backups	B75061013
Function module D	Visualisation application	B75061014
Function module E	Virtual devices	B75061015
Function module F	Integration of third-party devices	B75061016

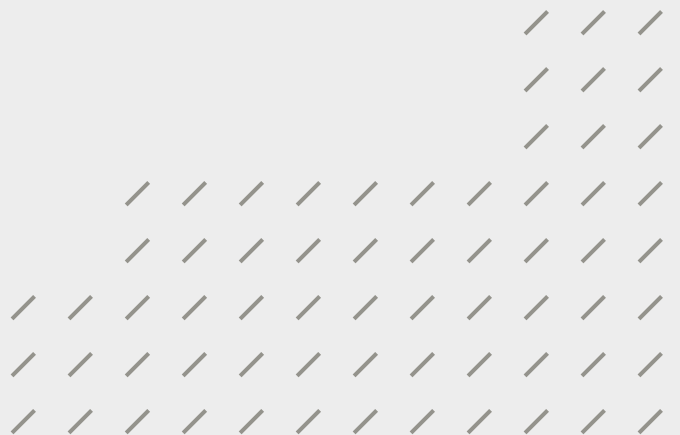

EDS insulation fault location systems

ISOMETER® with locating current injector



ISOMETER®
iso685-...-P



ISOMETER®
iso1685DP

ISOMETER®
isoLR1685DP

Circuits	Control circuits	✓	—	—
	Auxiliary circuits	✓	—	—
	Main circuits	✓	✓	✓
Voltage system	3(N)AC	✓	—	—
	AC	✓	✓	✓
	AC/DC	✓	✓	✓
	DC	✓	✓	✓
Nominal system voltage U_n		AC, 3(N)AC 0...690 V DC 0...1000 V	AC 0...1000 V DC 0...1500 V	AC 0...690 V DC 0...690 V
Tolerance of U_n		+15 %	AC +10 % DC +5%	AC +10 % DC +5%
System leakage capacitance C_e		≤ 1000 µF	≤ 2000 µF	≤ 2000 µF
Response value R_{an}		1 kΩ...10 MΩ	200 Ω...1 MΩ	20 Ω...100 kΩ
Coupled systems		✓	✓	✓
Locating current injector for insulation fault location		✓	✓	✓
Mounting	DIN rail	✓	—	—
	Screw mounting	✓	✓	✓
	Panel mounting/ wall fastening	✓	—	—
Interface	Web server	✓	—	—
	Modbus	TCP	RTU	RTU
	BCOM	✓	—	—
	BS	✓	—	—
	BMS	—	✓	✓

Ordering information

Type	Supply voltage U_s	Nominal system voltage U_n	Art. No.
iso685-D-P ¹⁾	AC 100...240 V; 47...460 Hz / DC 24 V, 100...240 V	AC, 3(N)AC 0...690 V,	B91067030
iso685-S-P + FP200 ¹⁾		DC 0...1000 V	B91067230
iso1685DP-425	DC 18...30 V	AC 0...1000 V/DC 0...1500 V	B91065802
isoLR1685DP-325		AC 0...690 V/DC 0...690 V	B91065803

¹⁾ Device variant "option W" with increased shock and vibration resistance: specify order number with "W" at the end

EDS insulation fault location systems

Fast localisation of insulation faults

Fast localisation and elimination of insulation faults is required by DIN VDE 0100-410 (VDE 0100-410). The iso685-...-P resp. isoxx1685DP in combination with the EDS system is a modular system that solves this problem. The application areas for EDS systems are very diverse.

They are operated/used for **main and control circuits** e.g. in:

- Power plants
- Shipbuilding
- Traffic engineering
- Industrial plants
- Paper industry
- Oil and natural gas industry
- Mining, open-cast mining
- Rolling mills
- Mechanical engineering
- and many other areas

Advantages of EDS insulation fault location systems

- Disconnection of the electrical installation is not required, insulation fault location takes place during operation
- Fast localisation of faulty circuits
- Information about the location of the fault is centrally displayed
- Combination with portable insulation fault location systems EDS3090/3090PG and EDS3091/3091PG
- Reduced maintenance and repair costs

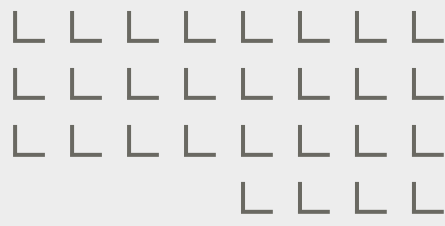

Application example

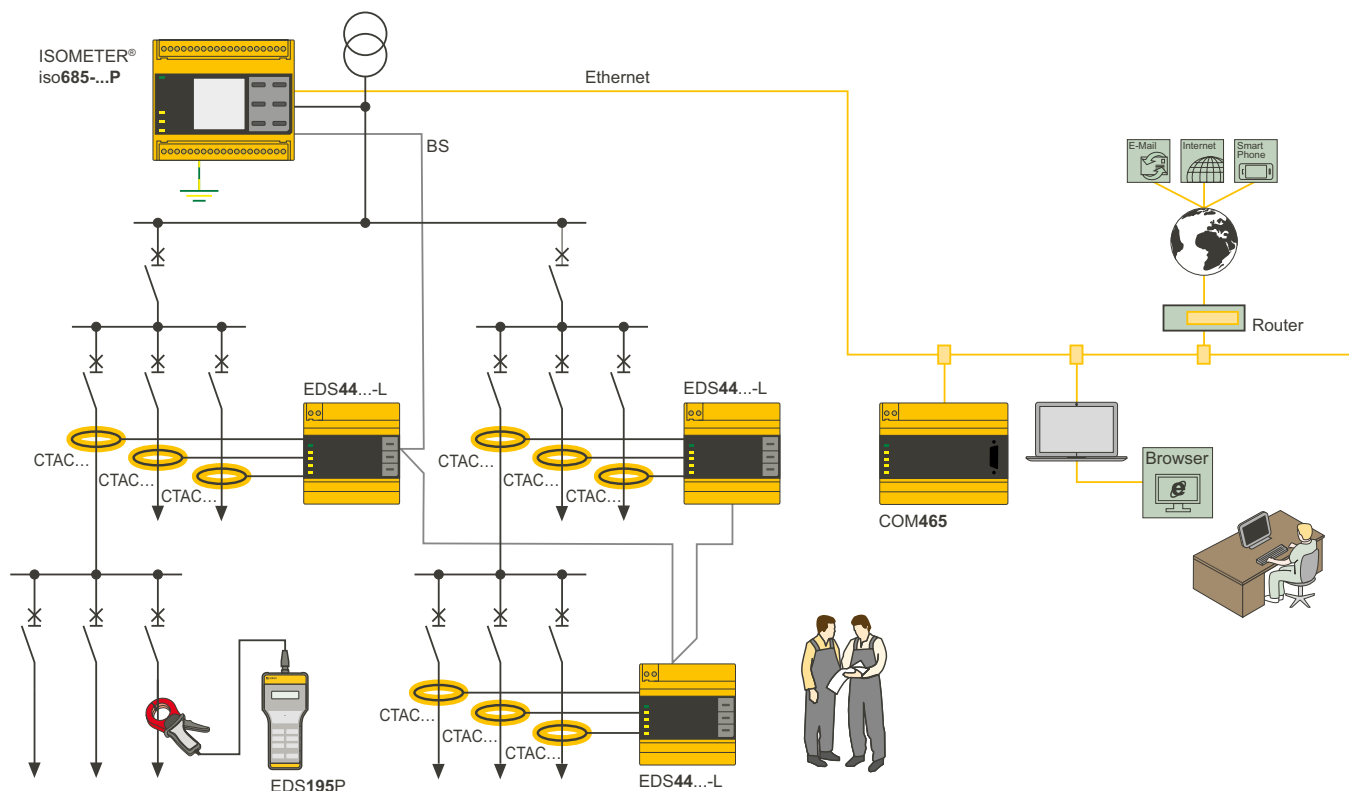

EDS insulation fault location systems

ISOSCAN® with locating current injector



	ISOSCAN® EDS440-S	ISOSCAN® EDS440-L	ISOSCAN® EDS441-S	ISOSCAN® EDS441-L	ISOSCAN® EDS441-LAB	ISOSCAN® EDS440-LAF
Application	—	—	—	—	High-resistance insulation faults for high system leakage capacitance and low locating current value	Use with flexible CTAF strap current transformers
Circuits						
Control circuits	—	—	✓	✓	✓	—
Main circuits	✓	✓	—	—	—	✓
Voltage system						
3(N)AC	✓	✓	—	—	—	—
AC	✓	✓	✓	✓	✓	✓
AC/DC	✓	✓	✓	✓	✓	✓
DC	✓	✓	✓	✓	✓	✓
Display						
Power On LED	✓	✓	✓	✓	✓	✓
Alarm LEDs	—	✓	—	✓	✓	✓
Mounting						
DIN rail	✓	✓	✓	✓	✓	✓
Screw mounting	✓	✓	✓	✓	✓	✓
Interface	BB	BS	BB	BS	BS	BS

Ordering information

Type	Supply voltage U_s	Response value	LED display	Art. No.
EDS440-S-1	AC/DC 24...240 V	2...10 mA	—	B91080201
EDS440-L-4			✓	B91080202
EDS440-LAF			✓	B91080209
EDS441-S		0.2...1 mA	—	B91080204
EDS441-L-4			✓	B91080205
EDS441-LAB			✓	B91080207

EDS insulation fault location systems

ISOSCAN® with integrated current transformer

		ISOSCAN® EDS150	ISOSCAN® EDS151
		stationary	stationary
Application		stationary	stationary
Circuits	Control circuits	—	✓
	Main circuits	✓	—
Voltage system	3(N)AC	—	—
	AC	✓	✓
	AC/DC	✓	✓
	DC	✓	✓
Mounting	DIN rail	—	—
	Screw mounting	✓	✓

Ordering information

Type	Circuits	Measuring range	Response value		Supply voltage U_s 1)	Art. No.
			EDS function	RCM function		
EDS151	Control circuits	0.5...2.5 mA	0.5 mA	1 A	AC 17...24 V 50...60 Hz	B91080101
EDS150	Main circuits	5...25 mA	5 mA	10 A	DC 14...28 V	B91080103

1) Absolute values

EDS insulation fault location systems

Portable equipment

Locating current injector		PGH185	PGH186	PGH183
				
Circuits	Control circuits	—	—	✓
	Main circuits	✓	✓	—
Application		energised	offline	energised
Nominal system voltage U_n		3AC, AC 20...575 V DC 20...504 V	3AC, AC 0...575 V DC 0...504 V	AC 20...265 V, DC 20...308 V
U_s AC 230 V		(PGH185)	(PGH186)	(PGH183)
U_s AC 90...132 V		(PGH185-13)	(PGH186-13)	(PGH183-13)
Locating current I_L max.		10/25 mA	10/25 mA	1/2.5 mA

Isolationsfehlersuchgerät		EDS195PM
		
LC display		3 x 16 characters
Evaluating current $I_{\Delta L}$		0.2...50 mA
Response value		0.2 ... 1/2...10 mA selectable

Strap current transformers		CTAF500	CTAF1000
			
Strap 500 mm		✓	—
Strap 1000 mm		—	✓

Complete systems		EDS3090	EDS3091
			
Circuits	Control circuits	—	✓
	Main circuits	✓	—

Measuring clamps		PSA3020	PSA3320
			
20 mm		✓	✓
52 mm		—	—
115 mm		—	—

		PSA3052	PSA3352
			
20 mm		—	—
52 mm		✓	✓
115 mm		—	—

		PSA3165 (optional)
		
20 mm		—
52 mm		—
115 mm		✓



EDS309... components

Device type	Aluminium case with carrying strap Operating manual		EDS195PM with accessories					PGH18... with accessories for						Measuring clamps				
			Insulation fault locator	Terminal connector to 4 mm	Adapter BNC/4mm plug for current transformer	Adapter BNC-PS2 for WF current transformer, optional	Plug-in power supply unit for EDS195PM	Locating current injector	Power supply cable for PGH18...	Safety measuring lead, black	Safety measuring lead, green/yellow	Safety claw grip, black	Safety claw grip, green/yellow	Coupling device, optional (for EDS3096PV only; included in the scope of delivery)	Measuring clamps 20 mm	Measuring clamps 52 mm	Measuring clamps 115 mm, optional	EDS set, optional
EDS3090	1	1	EDS195PM	1	1	1	1	—	—	—	—	—	—	PSA3020	PSA3052	PSA3165	1	
EDS3090PG	1	1	EDS195PM	1	1	1	1	PGH185	1	3	1	3	1	AGE185	PSA3020	PSA3052	PSA3165	1
EDS3090PG-13	1	1	EDS195PM	1	1	1	1	PGH185-13	1	3	1	3	1	AGE185	PSA3020	PSA3052	PSA3165	1
EDS3091	1	1	EDS195PM	1	1	1	1	—	—	—	—	—	—	PSA3320	PSA3352	—	1	
EDS3091PG	1	1	EDS195PM	1	1	1	1	PGH183	1	3	1	3	1	—	PSA3320	PSA3352	—	1
EDS3091PG-13	1	1	EDS195PM	1	1	1	1	PGH183-13	1	3	1	3	1	—	PSA3320	PSA3352	—	1
EDS3092PG	1	1	EDS195PM	1	1	1	1	PGH183 PGH185	2	6	2	6	2	—	PSA3320 PSA3020	PSA3352 PSA3052	—	1
EDS3096PG	1	1	EDS195PM	1	1	1	1	PGH186	1	3	1	3	1	AGE185	PSA3020	PSA3052	PSA3165	1
EDS3096PG-13	1	1	EDS195PM	1	1	1	1	PGH186-13	1	3	1	3	1	AGE185	PSA3020	PSA3052	PSA3165	1
EDS3096PV	1	1	EDS195PM	—	—	—	1	PGH186	1	3	1	3	1	AGE185	—	2x PSA3052	—	—

Ordering information

Type	Main circuits		Control circuits		Nominal voltage U_n	Supply voltage U_s	Art. No.
	with EDS	without EDS	with EDS	without EDS			
EDS3090	EDS440	—	—	—	AC 20...575 V, 42...460 Hz/DC 20...504 V	—	B91082026
EDS3090PG	—	✓	—	—	AC 20...575 V, 42...460 Hz/DC 20...504 V	AC 230 V, 50...60 Hz	B91082021
EDS3090PG-13	—	—	—	—		AC 90...132 V, 50...60 Hz	B91082022
EDS3096PG	—	—	—	—	AC 0...575 V, 42...460 Hz/DC 0...504 V	AC 230 V, 50...60 Hz	B91082025
EDS3096PG-13	—	—	—	—		AC 90...132 V, 50...60 Hz	B91082029
EDS3091	—	—	EDS441	—	AC 20...265 V, 42...460 Hz/DC 20...308 V	—	B91082027
EDS3091PG	—	—	—	✓	AC 20...265 V, 42...460 Hz/DC 20...308 V	AC 230 V, 50...60 Hz	B91082023
EDS3091PG-13	—	—	—	—		AC 90...132 V, 50...60 Hz	B91082024
EDS3092PG	—	✓	—	✓	AC 20...265 V, 42...460 Hz/DC 20...308 V	AC 230 V, 50...60 Hz	B91082030
	—	✓	—	✓	AC 20...575 V, 42...460 Hz/DC 20...504 V	AC 230 V, 50...60 Hz	
EDS3096PV	—	✓	—	—	AC 20...575 V, 42...460 Hz/DC 20...504 V	—	B91082031

Communication solutions

Modern communication

Since increasing demands are placed on communication capability, data transparency, and flexibility, the use of modern field bus and network technologies has become a must in the field of automation of electrical installations. For instance, operating, alarm and fault messages via the web or a network substantially contribute to increasing the transparency of power supply systems. At the same time, they allow fast responses to critical operating states. In addition, important messages can be transferred via text message or e-mail to the mobile phones or laptops of service personnel. Early information about the location and cause of a fault allows time and cost-efficient deployment of service personnel and helps avoid a possible installation failure or damage to expensive devices.

Electrical Safety Management

Under the heading "Electrical Safety Management" Bender offers comprehensive solutions for the electrical safety of power supply systems in all areas. Carefully matched products and systems with innovative measuring instruments, communication solutions for the visualisation of data from Bender monitoring systems as well as the easy connection to field bus and SCADA systems (Supervisory Control and Data Acquisition systems) provide the highest level of safety, economic efficiency and transparency. The range of products is completed by comprehensive services, which are provided for the entire service life of the products.

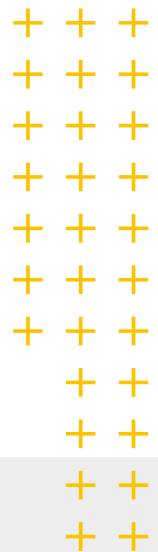

COM465IP

Condition monitor with an integrated gateway for the connection of Bender devices to Ethernet TCP/IP networks



CP9...-I

Condition monitor with an integrated gateway and touch screen for the connection of Bender devices to Ethernet TCP/IP networks

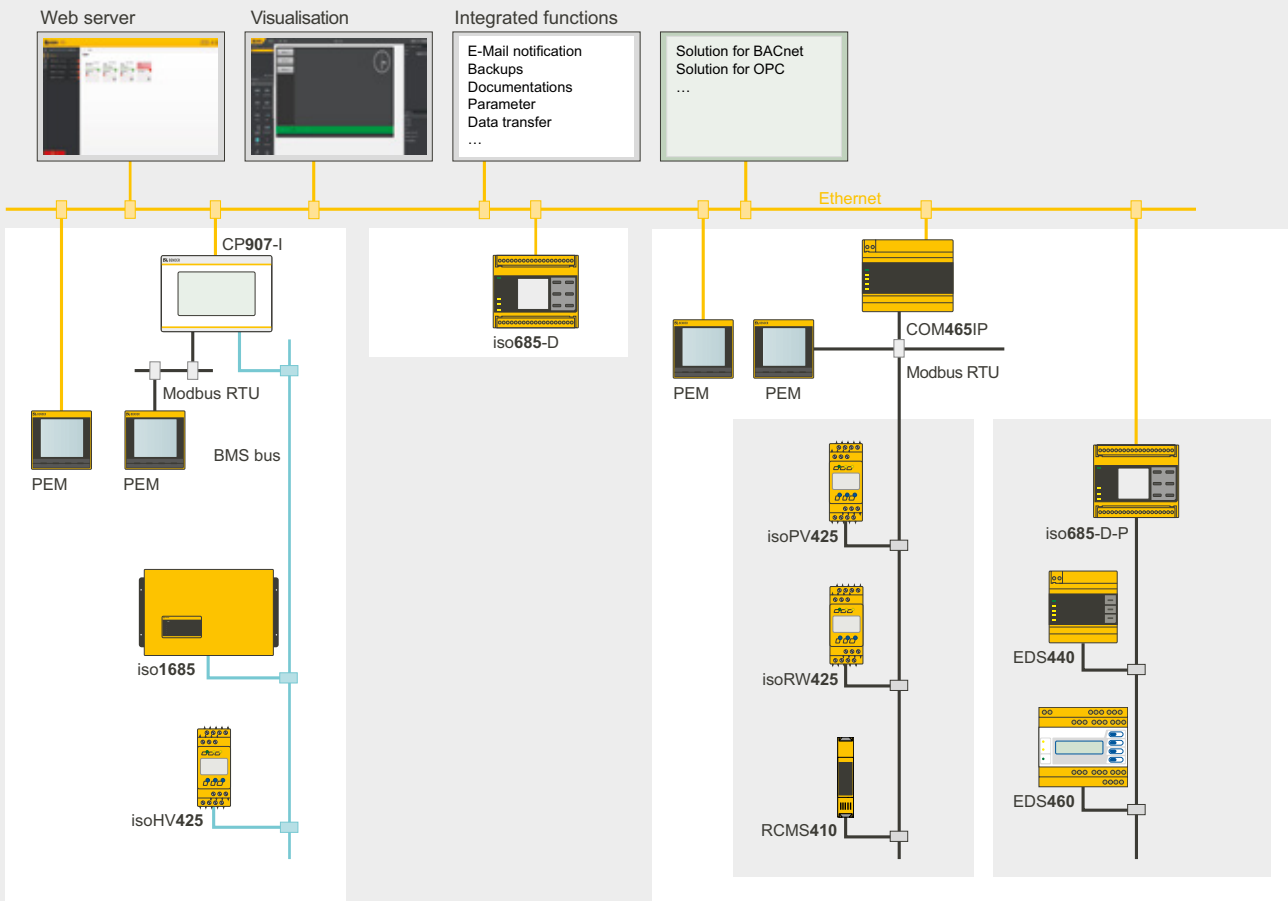

Electrical Safety Management: Comprehensive solutions for electrical safety in all areas with various Bender devices

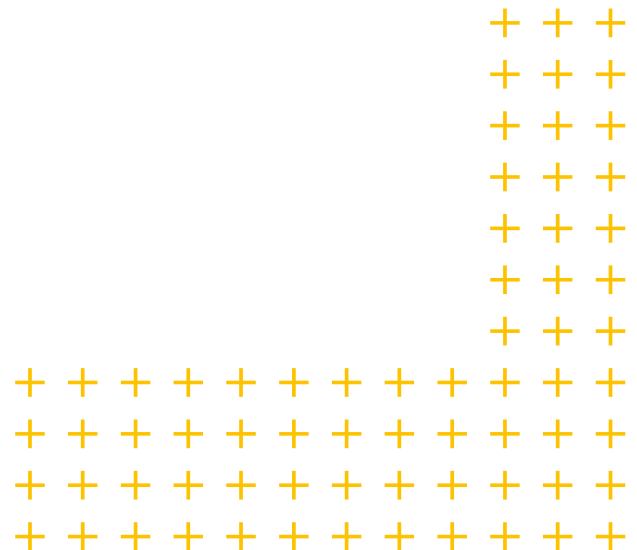

Retrofits

Untested devices and installations pose a safety risk

Is your installation still state-of-the-art?

Even the most modern electrotechnical installations are not immune to the effects of time. Whether it is decreasing operational reliability, changing legal conditions or rising energy costs: Adapting to the current state of the art is indispensable. Typically, products for monitoring energy quality and fault search are retrofitted.

Risk assessment according to Directive 2009/104/EC and its implementations in national law: Does your currently installed monitoring system detect symmetrical and asymmetrical insulation faults?

Symmetrical and asymmetrical insulation faults pose a high risk potential. With Bender insulation monitors, your installations are continuously monitored, insulation faults are detected and reported. Bender insulation monitors comply with IEC 61557-8.



Let us check your electrical installations and provide you with suggestions for the next steps.

Bender provides flexible solutions for retrofitting projects

Modern monitoring methods can also be integrated in old installations even during ongoing operation. Retrofitting is made possible by devices such as split-core current transformers, as the power supplies do not have to be switched off and cable systems do not have to be disconnected for the retrofit.

Successor devices from Bender can easily replace old devices.

Your advantages

- Well prepared for the standards of tomorrow
- Compliance with legal requirements
- Increased availability
- Update to the latest safety standard
- Cut costs and reduce energy consumption
- Ensure spare parts supply in the long term

Systematic and efficient modernisation at low cost!



Support during all stages remote, by phone, on site

From planning to modernisation – Our extensive know-how is at your disposal during all project phases.

Furthermore, with our first-class service we guarantee maximum safety for your electrical installations.

We offer services ranging from support over telephone to repairs and on-site service – with modern measuring devices and competent employees.

Be on the safe side:

- High availability of your installation thanks to fast reaction to fault messages
- Increased return on your capital expenditure (CAPEX) via optimised maintenance processes
- Targeted reduction of the operating expenditure (OPEX) due to reduced downtimes and shorter service visits
- Support for your predictive installation monitoring and regular tests of your installation/power quality/ monitoring devices

- Automatic checks, analysis, correction, new settings/updates
- Competent assistance with parameter changes and updates

Bender Remote Assist

Bender Remote Assist offers you support via remote access, high-quality service and advice for your challenging task of ensuring consistent high safety in your installations.

For, in many cases service visits, fault clearance but also analysis and controls can be carried out remotely – without the expenses of time and money that an on-site visit of a technician implies.

This fast, efficient help and advice by our expert network allows the highest possible availability of your installation.



Competent service for maximum safety and high availability of your installation

Fault location – made easy

With portable insulation fault location systems, existing insulation faults can be located quickly. They are the best alternative if no stationary insulation fault location systems are available.

POWERSCOUT®

Maximum transparency with minimum expenditure

Moisture, deterioration, dirt, mechanical damage or faults due to the impact of current, voltage and temperature cause malfunctions in every electrical installation. The web-based software solution POWERSCOUT® helps you detect malfunctions at an early stage and eliminate the causes in an economically reasonable way. This guarantees a high safety level for the installation as well as high operational reliability, and it reduces costs.

Analysis – as individual as your installation – as simple as possible

Predictive maintenance prevents downtimes, reduces costs and personnel expenditure. POWERSCOUT® informs you about the condition of your electrical installation at all times, since the informative visualisations with flexible dashboards can be retrieved via any display device, be it a smartphone, a laptop or a PC. On request, POWERSCOUT® sends you these graphically processed reports at specified intervals.

Continuous monitoring instead of random tests

Manual data acquisition is time consuming, error-prone and only provides random results. With POWERSCOUT® you have the complete data of your installation at your disposal at any time since all measured values are automatically and continuously saved. Your data is stored reliably and remains available for years.

Basis for periodic verification as per IEC 60364-6

The automated POWERSCOUT® report on residual currents forms the basis for measuring without switch-off by means of periodic verification as per IEC 60364-6. In order to maintain the correct status for electrical installations and stationary electrical equipment, periodic verification must be carried out.

This can be ensured, for example, when the installation is monitored continuously by qualified personnel. In this case, it is a smart move to rely on continuous monitoring with multi-channel residual current monitoring systems (RCMS) and an evaluation adapted to the installation (COMTRAXX® series). The automatic POWERSCOUT® reports based on this monitoring enable the qualified person in charge to adjust the times when the insulation test shall be performed as part of the periodic verification.

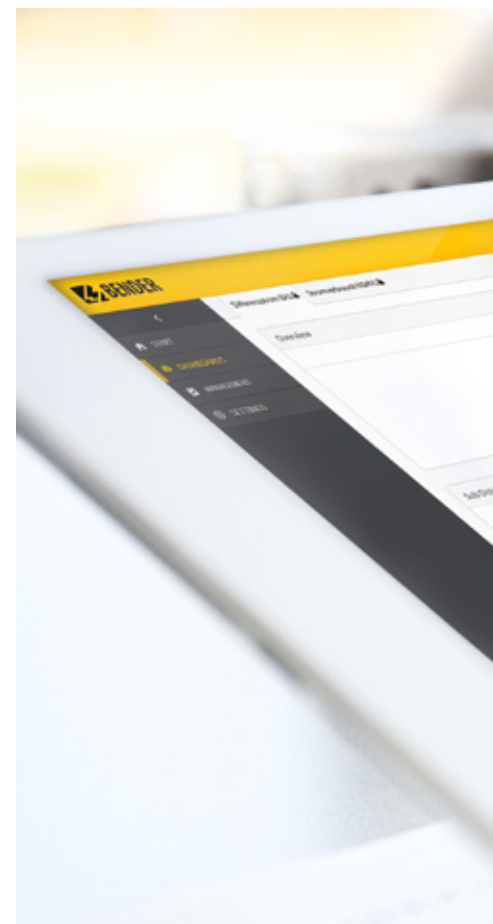

POWERSCOUT®: The web-based software solution for analysis, predictive maintenance, and reporting.

Analysis

- Continuously recording insulation values
- Recognising correlations and optimising processes
- Cross-plant evaluation options
- Access from any location
- Support for investment decisions

Report

- Historical comparisons
- Reliable storage of measured values
- Event and alarm statistics

Predictive maintenance

- Higher availability
- Continuous monitoring
- Early detection of gradually developing insulation faults
- Early detection and reporting of short-time insulation degradation
- Lower costs incurred due to unexpected malfunctions and shutdowns

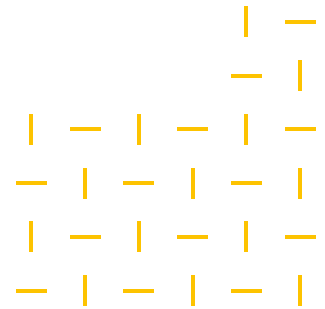



Bender. Making your world safe.

Our world is networked on a global scale; it is digital, mobile and highly automated. And no matter whether in hospitals, in industry, inside or outside buildings, in power stations, in trains, underwater or underground: it never stands still and it is more dependent than ever on a reliable and, above all, safe electrical power supply.

And exactly that is our mission: We make electricity safe. With our technologies, we ensure that electricity is permanently available and guarantee faultless protection against the hazards of electricity. We protect buildings, installations and devices, and therefore your investments and plans. But what we primarily protect are the lives of the people behind the electrical installations.



Mechanical and plant engineering



Oil, gas



Renewable energy



Healthcare



Public power supply network



Mobile power generation

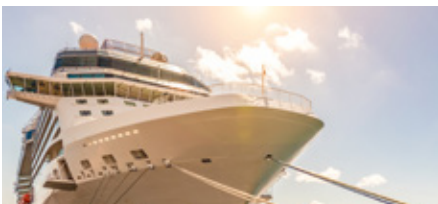

Ships and ports



Railway



eMobility



Data centres



Mining



Battery energy storage systems (BESS)

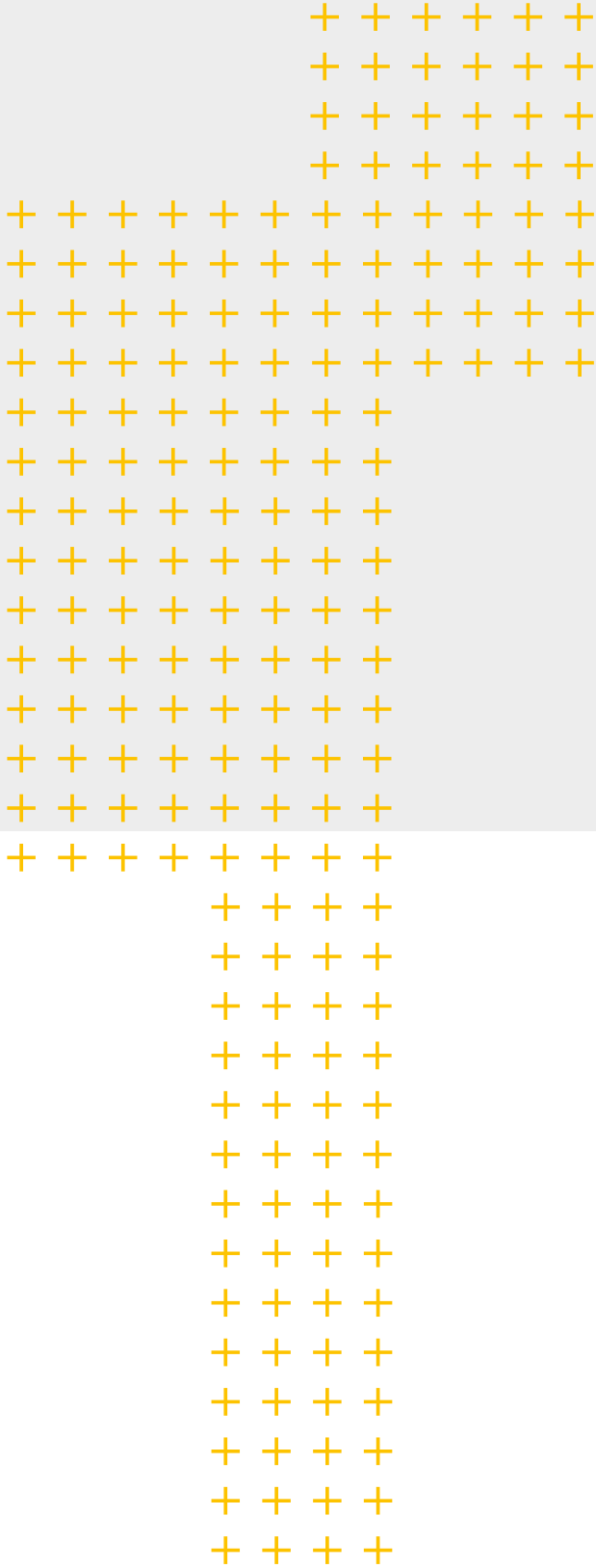

Bender GmbH & Co. KG

Londorfer Straße 65
35305 Grünberg
Germany

Tel.: +49 6401 807-0
info@bender.de
www.bender.de/en

Photos: AdobeStock (@2ragon, @agnormark, @EwaldFröch, @Gorodenkoff, @IgnacioFerrándiz, @JoseLuisStephens, @kbarzycki, @koldunova, @mimadeo, @NancyPauwels, @sommersby, @Southworks, @TeacherPhoto, @totojang1977, @visoot, @malp, @industrieblick) and Bender Archive.

2123en / 02.2024 / © Bender GmbH & Co. KG, Germany – Subject to change! The specified standards take into account the version valid at the time of printing.

